

INSTALLATION SHEET GMC/Chevy Stepside '99-

TUFF TONNO™

extang
AMERICA'S BEST
SELLING TONNEAUS

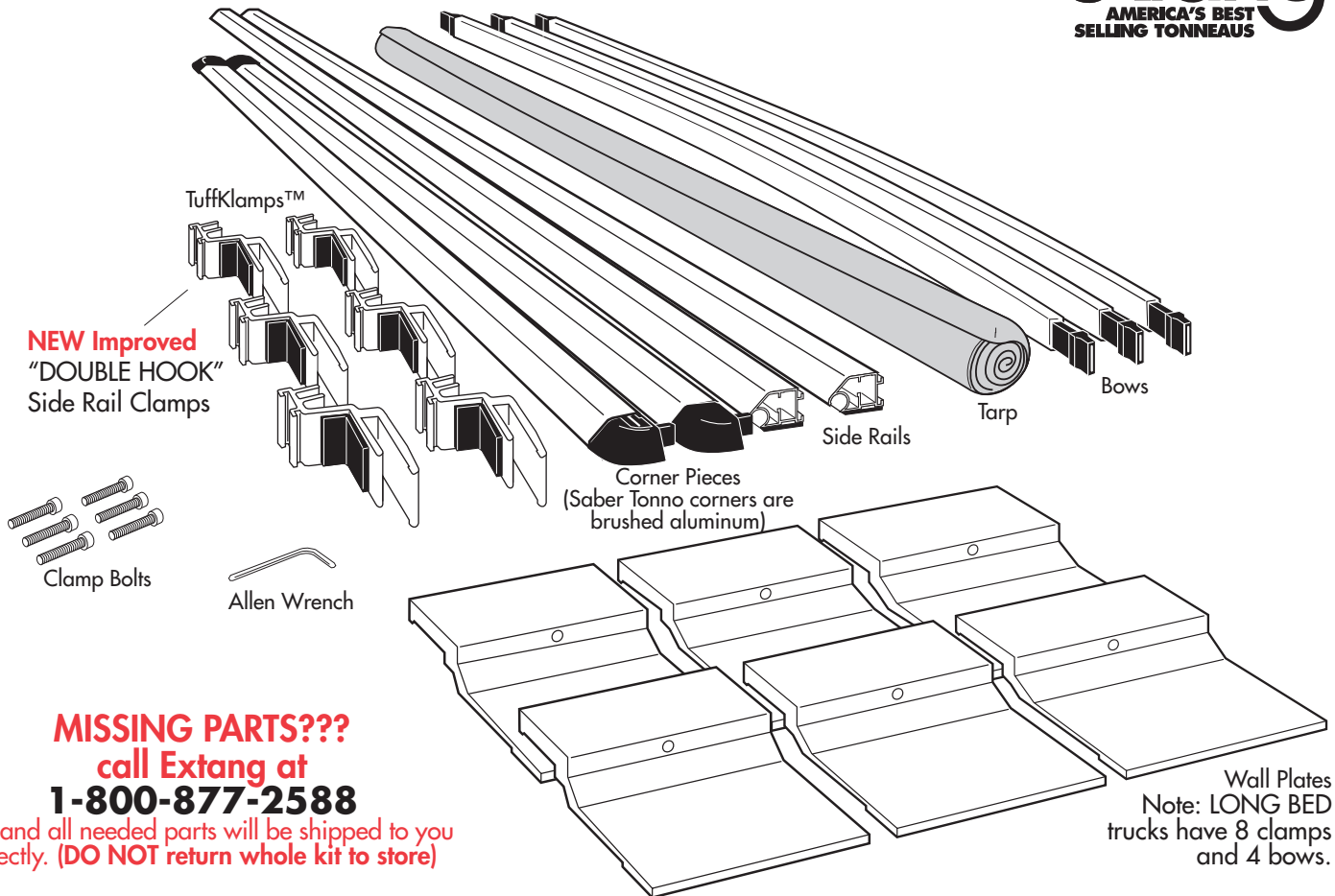

PARTS INCLUDED IN YOUR KIT. You may want to lay them out in this manner for accessibility.

1

Wash truck bed.

Alcohol Pad

IMPORTANT: Clean here with alcohol pad. (Both Sides)

2

Foam has NO adhesive to touch truck finish.

PLEASE DO NOT LITTER

Remove paper tape from all rails. Discard properly.

3

Depress the LeverLock™ mechanism, release, and remove one corner from cab rail.

Feed tarp dowel into cab rail.
(NOTE: For easiest feeding action, place tarp on a flat smooth surface, and keep dowel straight while feeding into cab rail. Caution, pavement may scuff tarp.)

Reinsert corner piece into cab rail until it "clicks" and locks into place.

4

Off the truck bed, connect the end rails to the two side rails.

Place assembly over truck box. Center between cab and tailgate.

Extang Corporation
1901 E. Ellsworth Rd.
Ann Arbor, MI 48108
734 677-0444, Fax: 734 677-8409

Register your warranty at:
www.extang.com

Item No. 0004-0708RH Printed in U.S.A.

5

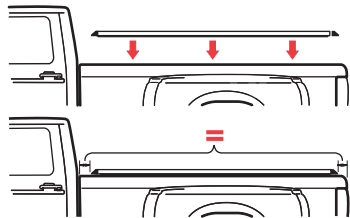

Place the rail assembly over the side of the truck box. Center rails evenly between cab and tailgate. (NOTE: Some applications have hard rubber risers (square rubber pad.) A riser must go toward tailgate. Some applications will have a riser at both ends, (most have no riser).)

When positioning wall plates be sure that they fit correctly against the truck bed wall. The plates must seat against the bottom of, and parallel to, the wall indentation.

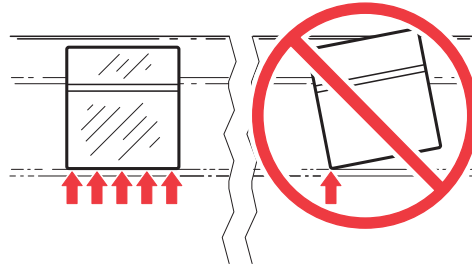
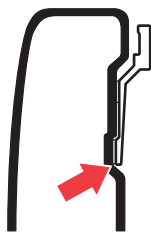

6

Clamp Spacing (Same for each side)

See the stickers located on each side rail for clamp position, or refer to the dimensions given below. Note: Remove stickers after installation.

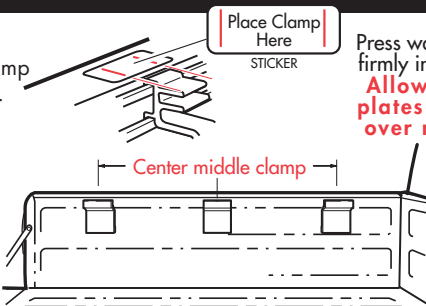
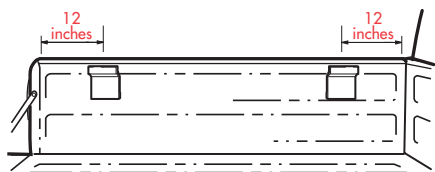

Place Clamp Here STICKER

Press wall plate firmly in place. Allow wall plates to set over night.

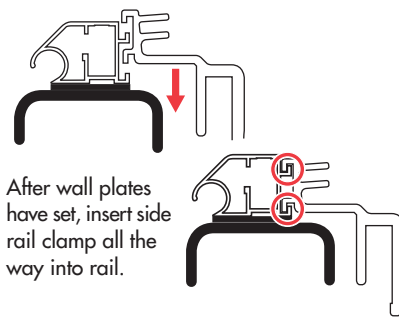

After wall plates have set, insert side rail clamp all the way into rail.

Note: Measure all distances from screw hole centers.

7

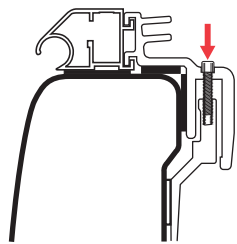

Insert clamp bolt in place. Do Not Overtighten

8

Insert bow onto top or bottom peg. (Top peg for performance, Bottom for good looks.)

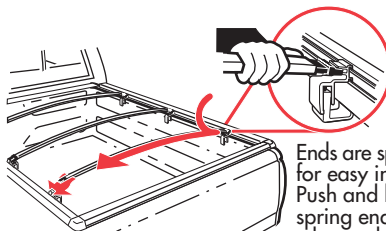

Ends are spring loaded for easy installation. Push and hold on spring end and let the other end slide on with the spring action.

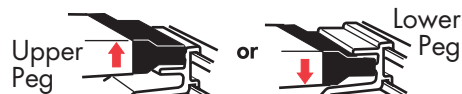

SPECIAL FEATURE: Two pegs offer two height adjustments.



Note: Bow End does not fit between pegs.

Do Not Place Between the Pegs

9

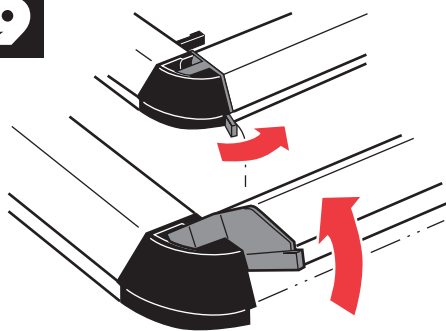

A. Release lever on both corners of tailgate rail and tilt rail up.

B. Attach tarp at front by pressing down on edge of tarp with the palms of your hands (about only 12 inches on each side). Then hook tarp to the tails rail's groove and click down to tighten tarp. See close-up.

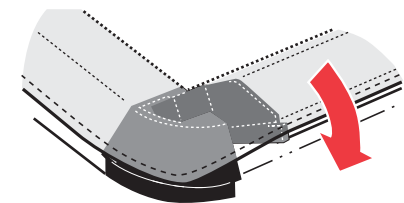
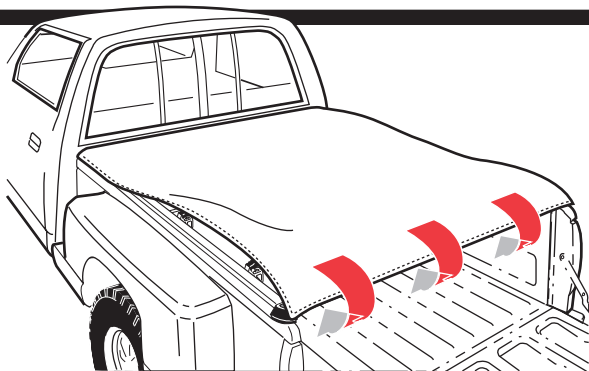

C. Close-up of downward rotation of rear rail. You will feel the "snap" effect and see it tighten snugly.

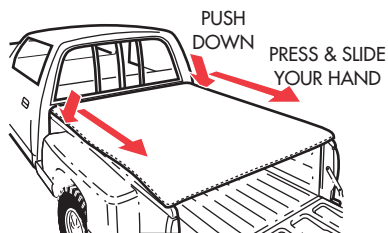

D. Finish attaching tarp along each side by pushing down and sliding your hand towards each corner. You can feel the "grip" action.

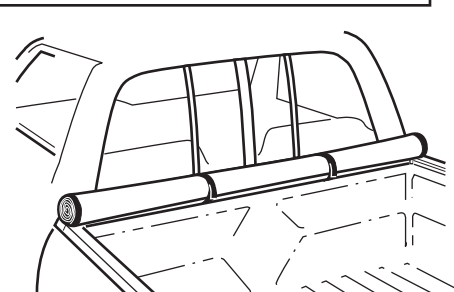

EASY USE OF TRUCK BED

Tarp may be rolled up and secured with Velcro® for bulk hauling

