

INSTALLATION SHEET Ford Flareside '04-



TUFF TONNO III™

& Saber TONNO

extang

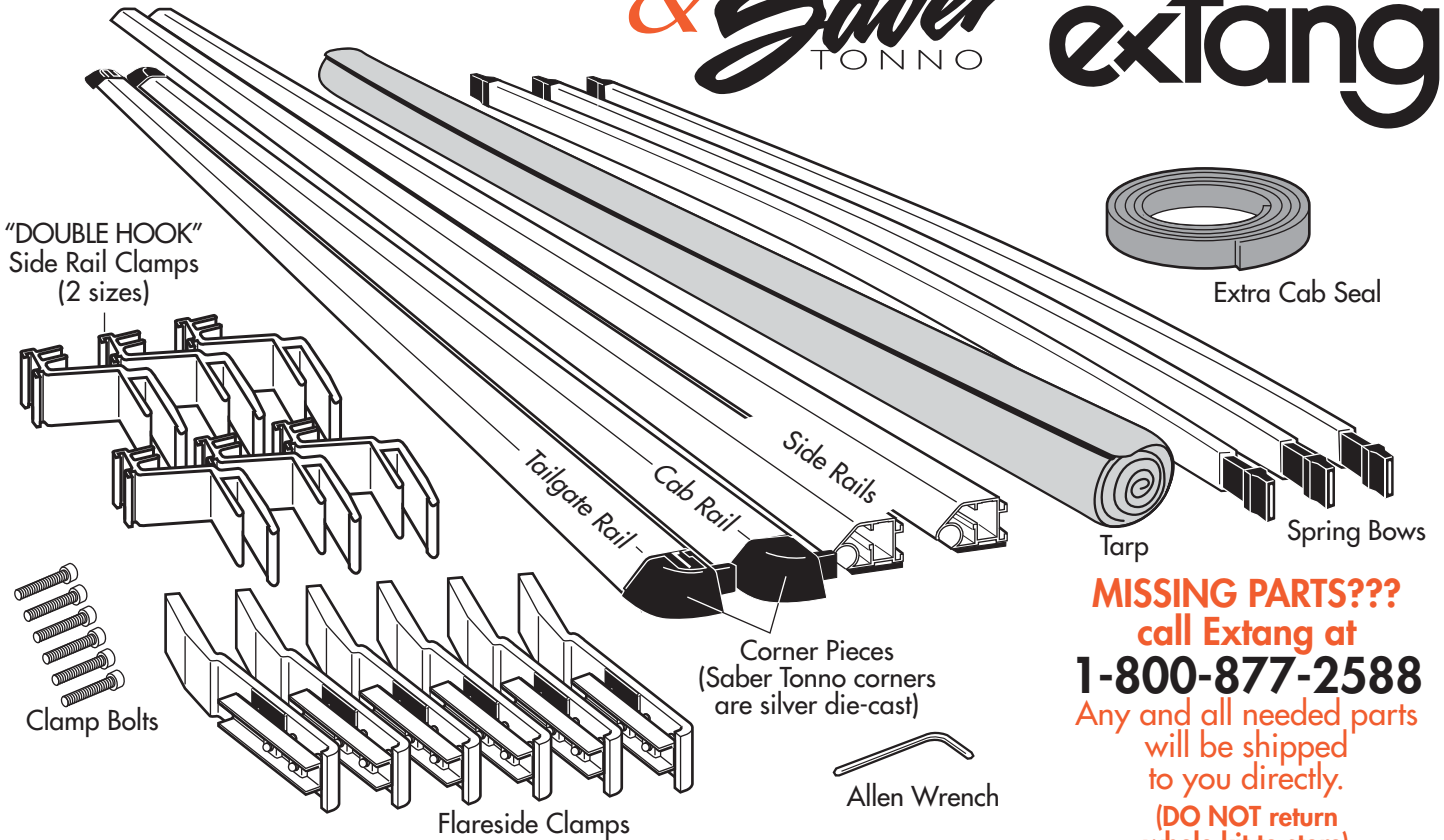

MISSING PARTS???
 call Extang at
1-800-877-2588
 Any and all needed parts
 will be shipped
 to you directly.
 (DO NOT return
 whole kit to store)

PARTS INCLUDED IN YOUR KIT. You may want to lay them out in this manner for accessibility.

1

Wash truck bed.

2

Foam has **NO adhesive** to touch truck finish.

Remove paper tape from all rails. Discard properly.

3

Depress the mechanism, release, and remove one corner from cab rail.

LeverLock™ (Tuff Tonno III)
 ClickLock™ (Saber Tonno)

4

Off the truck bed, connect the end rails to the two side rails utilizing the ClickLock™ clips.

Feed tarp dowel into cab rail. NOTE: For easiest feeding action, place tarp on a flat smooth surface, and keep dowel straight while feeding into cab rail.

Caution, pavement may scuff tarp.

Reinsert corner piece into cab rail until it "clicks" and locks into place.

extang
 Stands for Quality

Extang Corporation
 1901 E. Ellsworth Rd.
 Ann Arbor, MI 48108
 734 677-0444, Fax: 734 677-8409

Visit us at:
www.extang.com

Item No. 0145-0105 RH Printed in U.S.A.

5

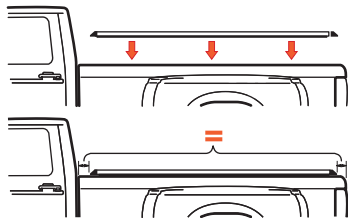

Place the rail assembly over the side of the truck box. Center rails evenly between cab and tailgate. (NOTE: Some applications have hard rubber risers (square rubber pad.) A riser must go toward tailgate. Some applications will have a riser at both ends, (most have no riser).

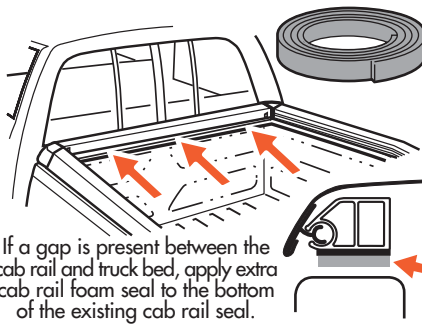

If a gap is present between the cab rail and truck bed, apply extra cab rail foam seal to the bottom of the existing cab rail seal.

For an OVER-THE-RAIL Bedliner

DIAGRAM A

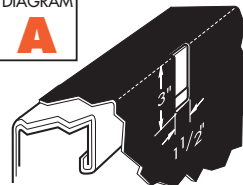
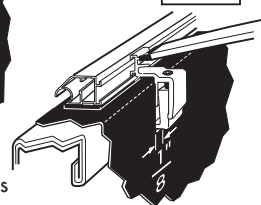

DIAGRAM B



For each clamp mark on your bedliner a 1-1/2" x 3" hole as shown above. Remove clamp. Cut holes in bedliner. Reinsert side rail clamp. Return to step 5.

Side rail clamped to bed with bow attached.

6

Note: For over-the-rail bed liners first refer to Diagrams A and B above.

Clamp Spacing (Same for each side) See the stickers located on each side rail for clamp position, or refer to the dimensions given below. Note: Use clamp intended for each position.—Remove stickers after installation.

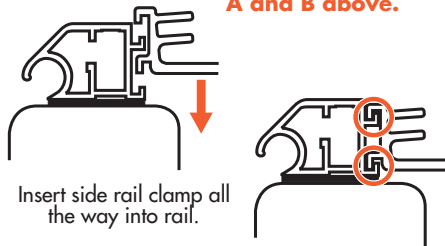

Insert side rail clamp all the way into rail.

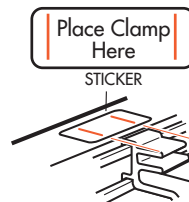
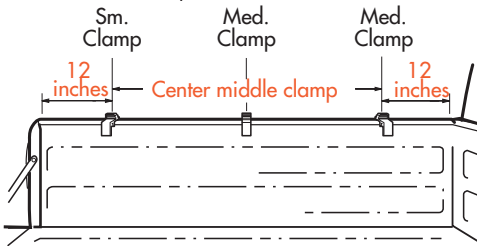

7

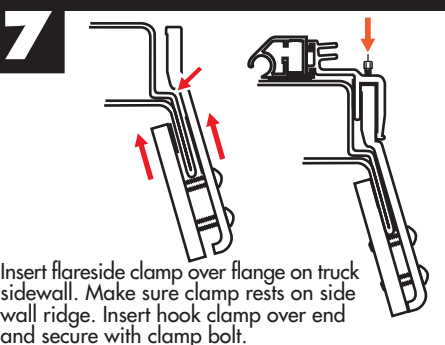

Insert flareside clamp over flange on truck sidewall. Make sure clamp rests on side wall ridge. Insert hook clamp over end and secure with clamp bolt.

8

Insert bow onto top or bottom peg. (Top peg for performance, Bottom for good looks.)

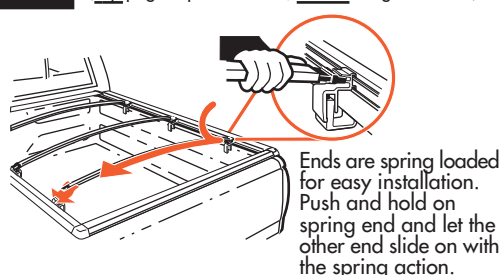

Ends are spring loaded for easy installation. Push and hold on spring end and let the other end slide on with the spring action.

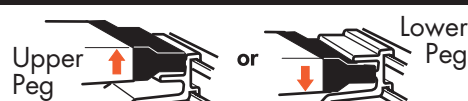

SPECIAL FEATURE: Two pegs offer two height adjustments.

Note: Bow End does not fit between pegs.

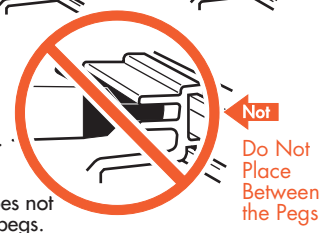

9

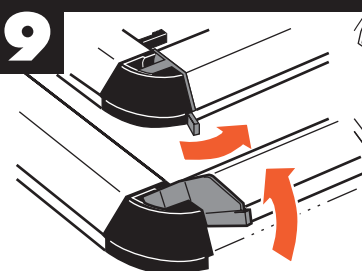

A. Release lever on both corners of tailgate rail and tilt up rail.

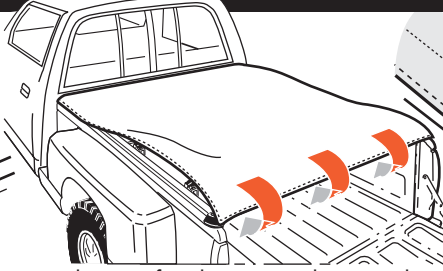

B. Attach tarp at front by pressing down on edge of tarp with the palms of your hands (about only 12 inches on each side). Then hook tarp to the tails rail's groove and click down to tighten tarp. See close-up.

Close-up of downward rotation of rear rail. You will feel the "snap" effect and see it tighten snugly.

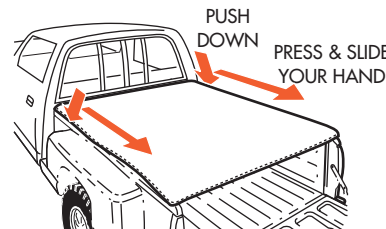

C. Finish attaching tarp along each side by pushing down and sliding your hand towards each corner. You can feel the "grip" action.

For Tuff Tonno III:

For Saber Tonno:

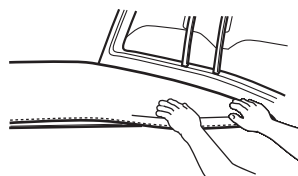

A. Attach tarp from front corner (12 inches). Repeat for each side. **Note: Pull tarp out while pressing down in center of the side strip to flex hook open for easy attachment.**

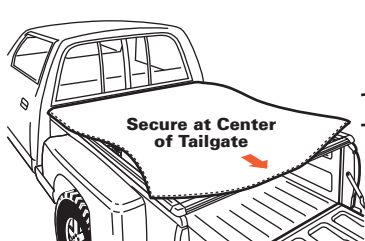

B. Secure tarp at the middle of tailgate rail.

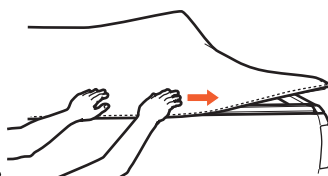

C. Finish attaching tarp along each side by pushing down and sliding your hand front to rear, and on tailgate rail, by pressing out from the center.

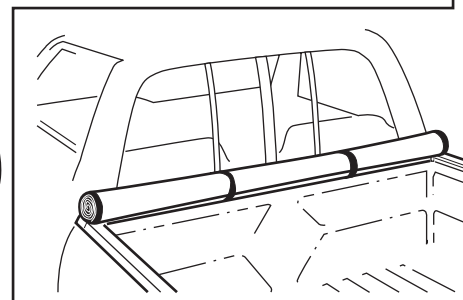

EASY USE OF TRUCK BED

Tarp may be rolled up and secured with Velcro® for bulk hauling